



3651 N. Highway 89 • Chino Valley, AZ 86323
(928) 636-7080 • www.p-a-g.net

CHEVY 1/2 & 3/4-TON 3" BODY LIFT KIT INSTALLATION INSTRUCTIONS 1999-2002 KIT #10053

⚠WARNING

Installation of a Performance Accessories body lift will change the center of gravity and the handling characteristics of the vehicle. Because of the higher center of gravity and larger tires, the vehicle will handle and react differently both on and off road. You must drive it safely! Extreme care must be taken to prevent vehicle rollover or loss of control, which could result in serious injury or death. Avoid sudden sharp turns or abrupt maneuvers and always make sure all vehicle occupants have their seat belts fastened.

⚠WARNING

Read and understand all instructions, warnings, cautions, and notes in this sheet and in your owners manual before you begin the installation of this body lift kit.

⚠CAUTION

Proper installation of a Performance Accessories body lift kit requires knowledge of the factory recommended procedures for disassembly and assembly of original equipment components. We recommend that the factory shop manual and any special tools necessary to your vehicle be on hand during the installation. Installation of this body lift kit without proper knowledge of the factory recommended procedures may affect the performance of these components and the safety of your vehicle. We strongly recommend that a certified mechanic familiar with the installation of similar components install this body lift kit.

⚠WARNING

This body lift kit should only be installed on vehicles in good working condition. Before installation, the vehicle should be thoroughly inspected for evidence of corrosion or deformation of the sheet metal around the factory body mounts. This body lift kit should not be installed on any vehicle that is suspected to have been in a collision or misused. Off road use of your vehicle with this body lift installed may increase the stress applied to the factory body mounts. We do not recommend that any vehicle with a body lift installed be involved in any extreme off road maneuvers such as jumping. Failure to observe this warning may result in serious personal injury and/or severe damage to your vehicle.

⚠WARNING

Many states now have laws restricting bumper heights and vehicle lifts. Local laws should be consulted to determine if the changes you intend to make to your vehicle comply with state laws.

⚠WARNING

The installation of larger wheel and tire combinations may reduce the effectiveness of the Anti-lock Braking System.

⚠WARNING

Always wear eye protection when operating power tools.

⚠WARNING

Ensure that your vehicle tires are properly blocked and secured before you begin installation of this lift kit.

⚠WARNING

The Supplemental Restraint System (SRS, or air bag) must be deactivated during lift kit installation to avoid accidental air bag deployment while working near SRS sensors and wiring. Do not allow anyone near the air bag during lift kit installation. Accidental deployment can result in serious personal injury or death. Refer to your factory service manual/owner's manual for the recommended procedure to disable the SRS. The SRS must be reactivated before driving the vehicle

⚠NOTE

Performance Accessories recommends using the Loctite® supplied in the kit on all hardware unless noted in the instructions.

⚠WARNING

DO NOT combine suspension, body, or other lift devices. Use of vehicle with combined lifts may result in unsafe and/or unexpected handling characteristics.

A. Before you start.

⚠NOTE

As you read through this procedure, note that each part referenced has the same callout number throughout. Also, the part number in the text matches the corresponding part number in the art. Kit parts are prefaced by the word *kit* in italics.

⚠NOTE

You will find it easier to keep track of hardware if immediately after removal you put the fasteners for each subassembly in a paper lunch bag and write on the bag where they go.

1. Read all warnings and instructions completely and carefully before you begin.
2. Check to make sure the kit is complete (refer to the Parts List, section E).
3. Only install this kit on the vehicle for which it is intended. If anytime during the installation you encounter something different from what is outlined in the instructions, call technical support at (928) 636-0979.
4. Park the vehicle on a clean, dry, flat, level surface and block the tires so the vehicle cannot roll in either direction.
5. Disconnect both battery cables. Disconnect the negative cable (1) first, then the positive cable (2) from the battery (3).
6. Remove cover (4) and the airbag fuse (5) from the fuse panel (6). Fuse locations may vary. Check fuse chart on back of cover (4).

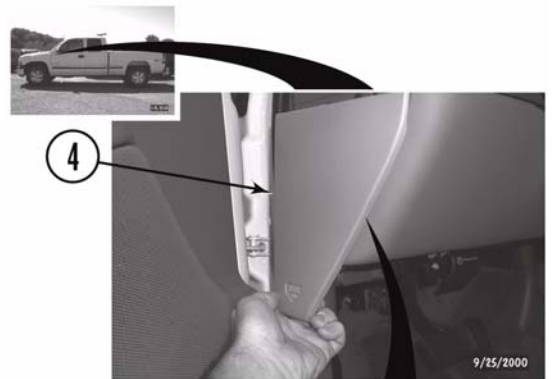
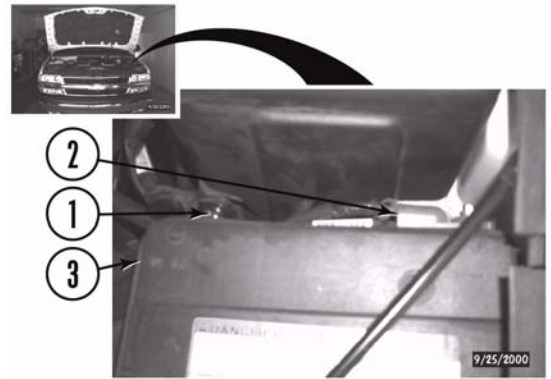

B. Get ready to install the kit.

1. Remove the grille.

- a. Remove seven panel clips (7) and cover (8) from core support (9).



- b. Remove bolt with captive washer (10), loosen four phillips head/dzeus fasteners (11), remove two clips (12) and grille (13) from core support (9) and front fenders (14).

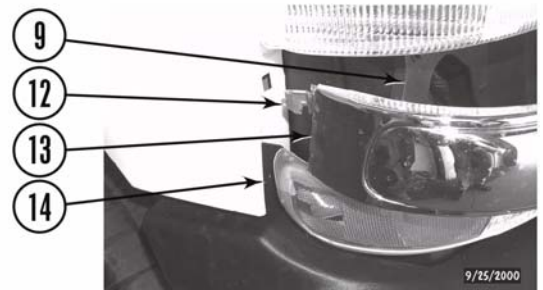

2. Remove the front bumper.

- a. Measure distance between the front bumper (15) and front fenders (14). Record measurement.

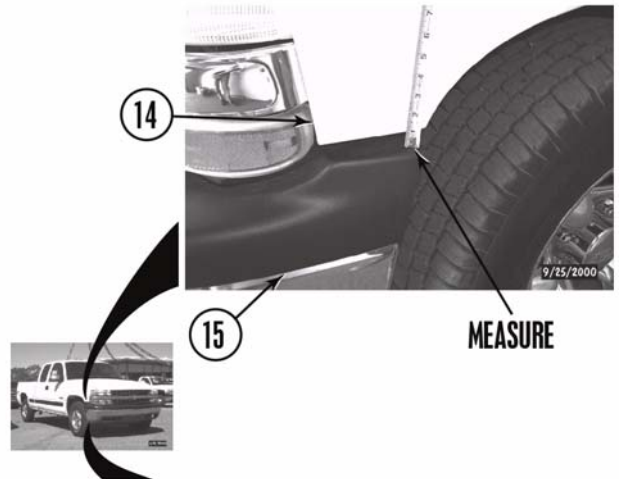

- b. Remove six bolts (16) and two front bumper side brace brackets (17) from front bumper (15) and frame (18).

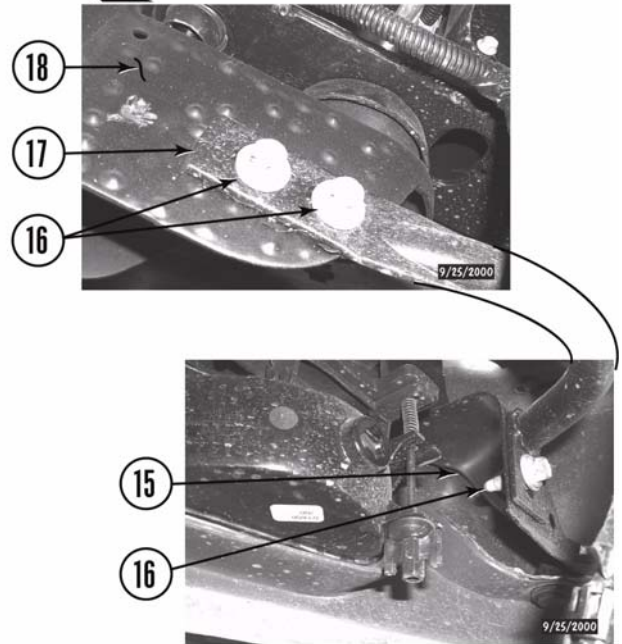

- c. Remove four bolts (19 and 20) and front bumper (15) from frame (18).

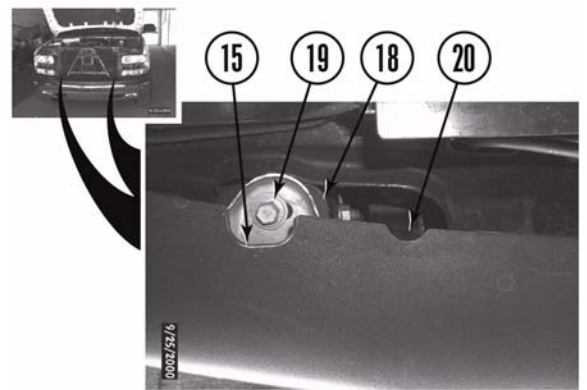

- d. Remove two nuts (21), bolts (22), washers (23), bolts with captive washers (24), and tow hooks (25) from the frame (18).

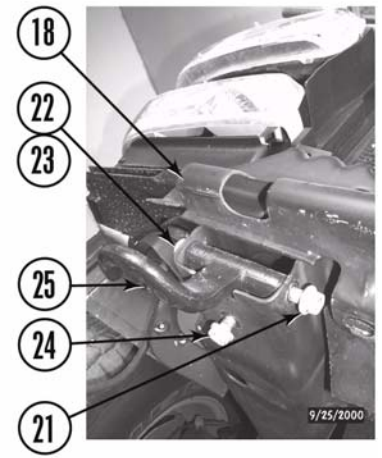

- e. Remove five bolts with captive washers (26) and plastic cover (27) from core support (9) and frame (18).

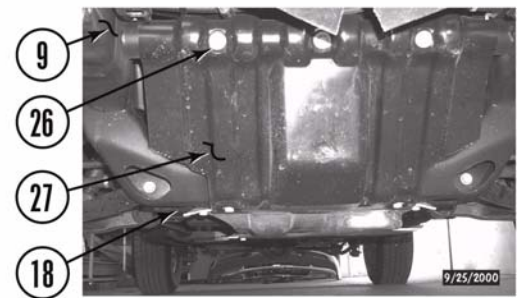

- f. If so equipped, remove clip (28) and harness (29) from air flap (30).
- g. Remove three panel clips (31) and air flap (30) from core support (9).

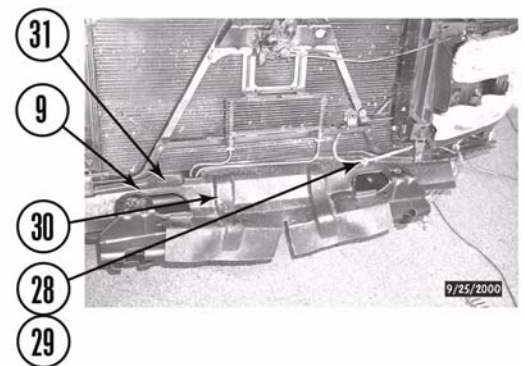

3. Transmission cooler (if so equipped).

- a. Remove two bolts (32), two panel clips (33), and transmission cooler (34) from core support (9). Remove two lines (35 and 36) from clips (37).

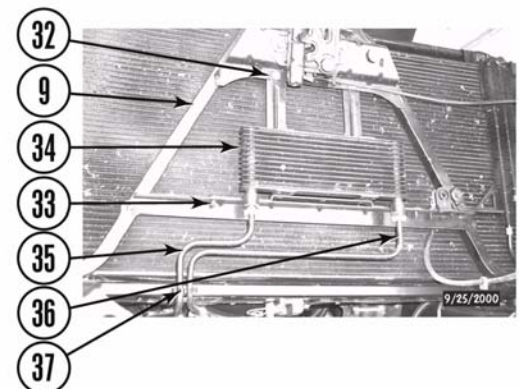

4. Under the hood.

- a. Remove hose (38) from two clamps (39 and 40).
- b. Loosen two clamps (41 and 42) and remove air duct (43) from air filter housing (44) and throttle body (45).

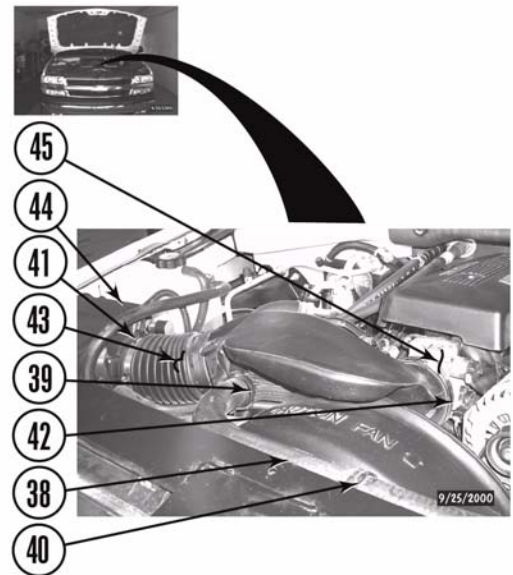

- c. Remove two bolts with captive washers (46) from core support (9).
- d. Remove four pop-ups (47) from top fan shroud (48) and bottom fan shroud (49).
- e. Remove top fan shroud (48) from bottom fan shroud (49), radiator (50) and vehicle. Rotate bottom fan shroud (49) around fan and remove from vehicle.



NOTE
Ensure steering shaft does not turn independently of the steering gearbox. This could cause the air bag system to malfunction, resulting in serious personal injury or damage to the equipment.

- f. Straighten steering wheel and strap the wheel so it will not turn.
- g. Remove bolt (51) and clip (52) and slide upper steering shaft (53) up to separate from lower shaft (54).

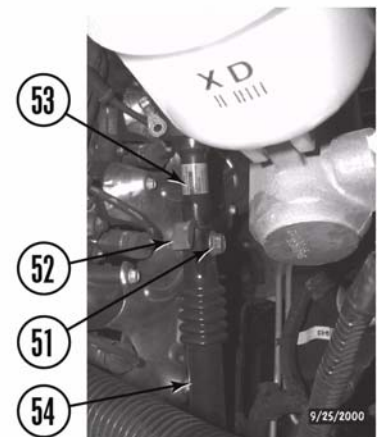

- h. Remove nut (55) and ground strap (56) from stud (57).

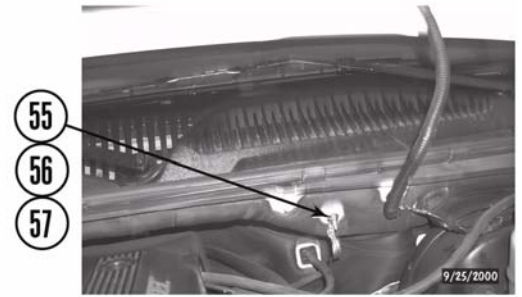

- i. Remove clip (58) from bracket (59).

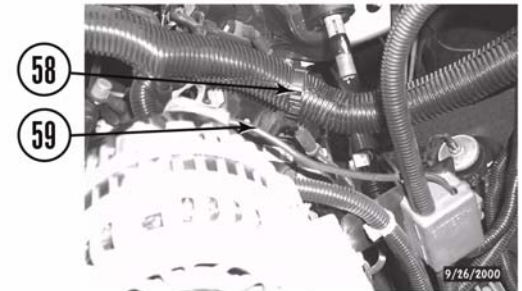

5. Along the frame rails.

- a. Remove clip (60) from frame (18) driver side. Remove harness (61) from clip.

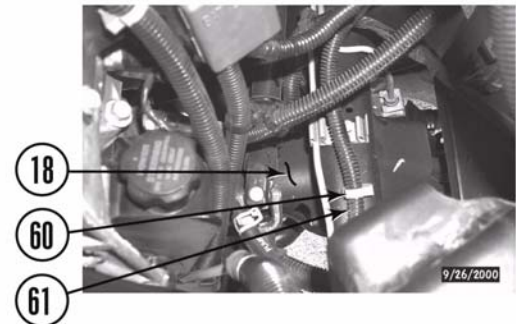

- b. Remove three clips (62, 63, and 64) from frame (18) driver side and wheel well (65).

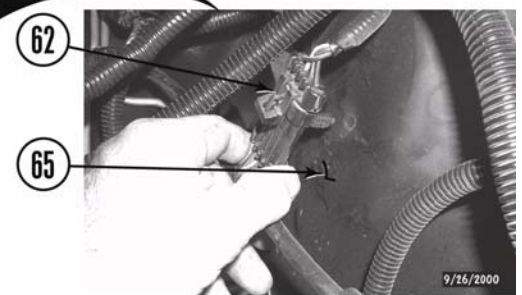

- c. Remove two brake lines (66) from two sets of clips (67).

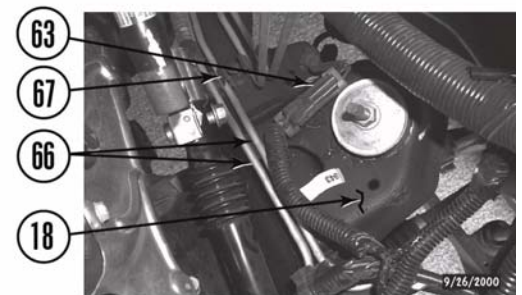

- d. Remove harness (61) from clip (68) and clip from frame (18).
- e. Remove (you may have to cut) clip (69) from frame (18).
- f. Remove bolt (70) and two ground wires (71 and 72) from driver side frame mounting pad (73).
- g. Remove two harnesses (61 and 74) from clip (75). Remove clip from frame (18) driver side.
- h. Pull some slack in front parking brake cable (76) and clamp cable with a vice grip.
- i. Separate front part of parking brake cable (76) from rear parking brake cable (77).
- j. Remove front part of parking brake cable (76) from driver side frame mounting pad (73).

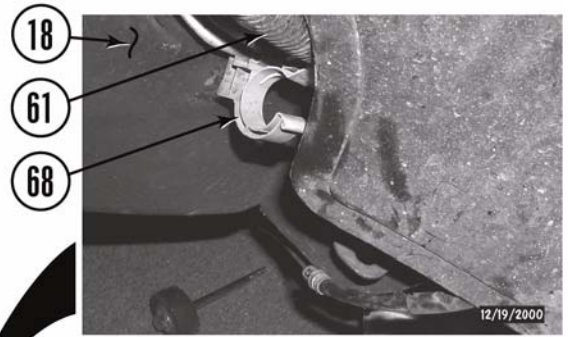

SEPARATE HERE

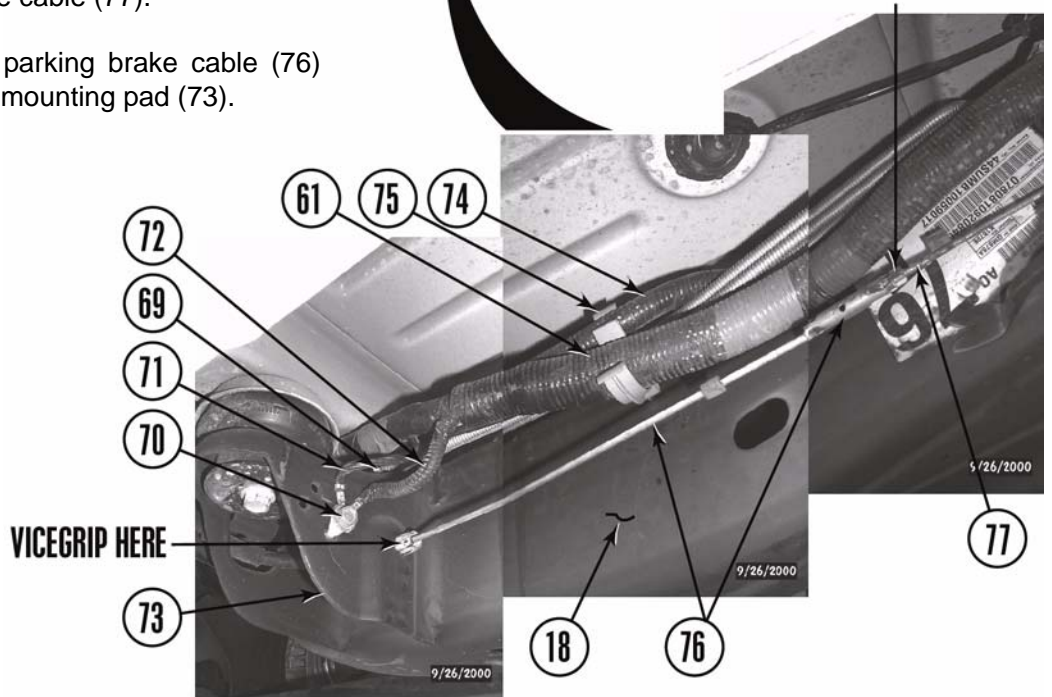

- k. Remove two clips (78 and 79), brackets (80 and 81), and harness (82) from frame (18) passenger side.

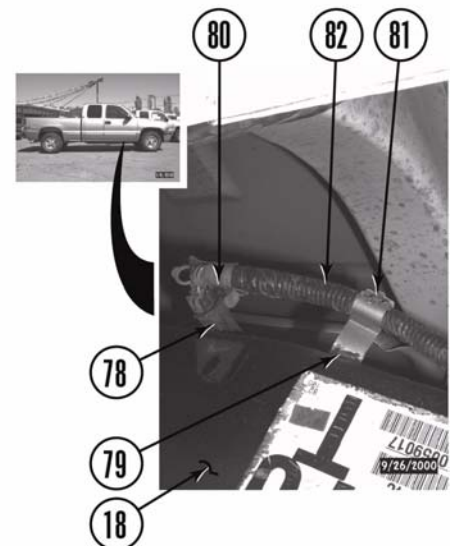

- I. Single cab only - remove two bolts (82a) and safety cables (82b) from two rear frame mounting pads (73).

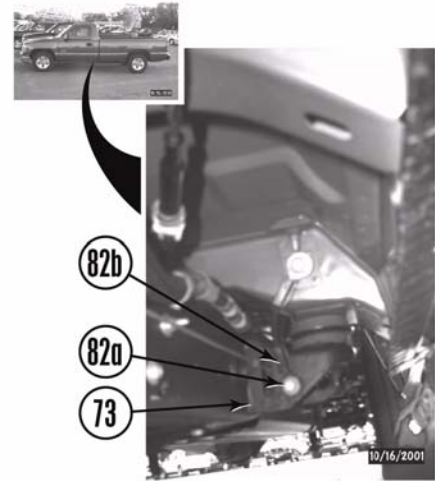

⚠WARNING
 Use extreme caution when working near fuel lines and fuel tank. Clean up spilled fuel immediately. Any spark could cause an explosion or fire resulting in serious personal injury and property damage.

- 6. Remove the fuel filler.
 - a. Remove gas cap (83).
 - b. Remove three bolts (84) from body (85) and fuel filler (86).

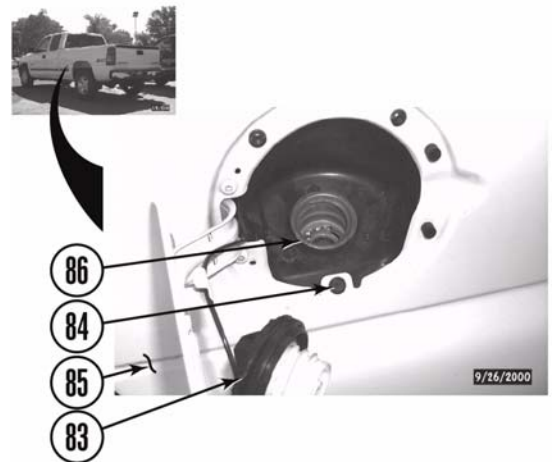

- 7. Remove the rear bumper.
 - a. Measure distance between rear bumper (87) and tailgate (88).
 - b. Remove hardware and license plate from bumper.
 - c. Remove spare tire (refer to the Owner's Manual).
 - d. Disconnect two license plate lights (89) from rear bumper (87).

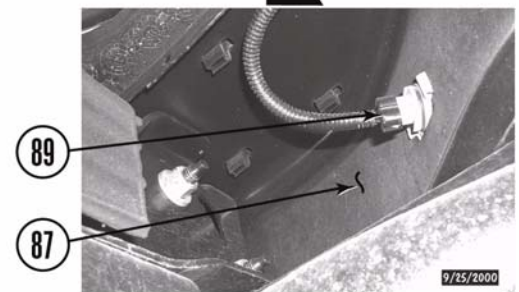

- e. Remove three clips (90) and harness (91) from rear bumper (87).

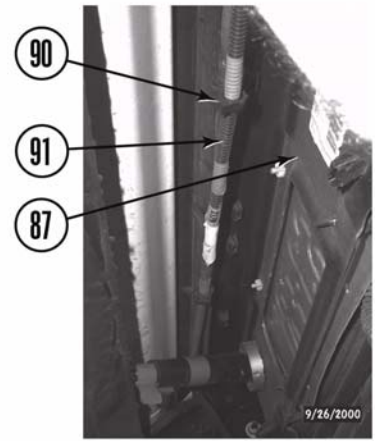

- f. Remove four nuts with captive washers (92) and two bolts with captive washers (93) from two rear bumper brackets (94), two rear outside bumper brackets (95), and frame (18).
- g. If equipped with factory class III trailer hitch (96), remove four bolts (97) from frame (18), rear bumper bracket (94), and rear bumper (87).
- h. Loosen but do not remove four nuts (98) and rotate two outside brackets (95) outward.
- i. Remove four bolts with captive washers (99) and four nuts with captive washers (100) from rear bumper brackets (94) and rear bumper (87).
- j. Remove rear bumper (87) and outside brackets (95) from vehicle. Remove rear bumper brackets (94) from frame (18).

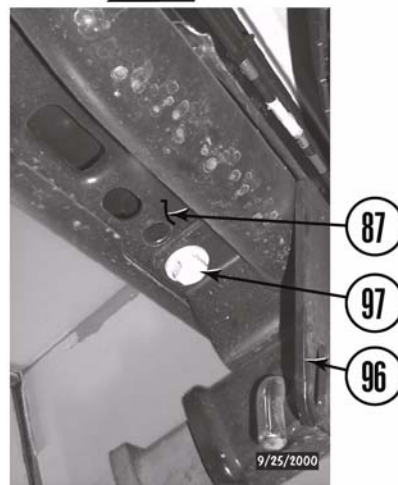

C. Install the kit.

1. Prepare to lift body from frame.

⚠WARNING

Failure to replace the OEM body mounting hardware (except mounting bolts in the kit) in the stock locations could result in serious personal injury or damage to the vehicle.

- a. Measure distance between cab (85) and bed (101). Record measurement for later cab to bed alignment reference in these instructions.
- b. Hold two core support bolts (102) and loosen but do not remove two nuts (103) from core support mounting pads (104).
- c. Loosen but do not remove six body mounting bolts with captive washers (105).

⚠WARNING

Use extreme caution when lifting body from frame. Ensure lifting device is securely placed. Keep hands out from between frame and body, or serious personal injury could result.

⚠CAUTION

Continually check hoses, wires, lines, etc. to be sure that everything is flexing properly and not binding, or damage to the vehicle could result. Be especially careful of the a/c hoses at the fire wall, the belt pulley, and at the core support. Ensure brake lines stretch while lifting. Bending the lines to gain ample slack may be necessary. Be extremely careful not to kink the lines.

⚠NOTE

Ensure stock spacers and body mounting pads stay on vehicle unless otherwise specified in these instructions. Kit spacer blocks are installed in addition to the stock spacers and body mounting pads.

⚠NOTE

Passenger side core support bolt can be removed but driver side core support bolt cannot until body is lifted.

- d. Remove nut (103), washer (106), bottom bushing (107), washer (108), and bolt (102) from the passenger side core support mounting pad (104) and passenger side frame mounting pad (109).
- e. Remove three bolts with captive washers (105) and bottom bushings (107) from the passenger side frame mounting pads (109) and body mounting pads (110).

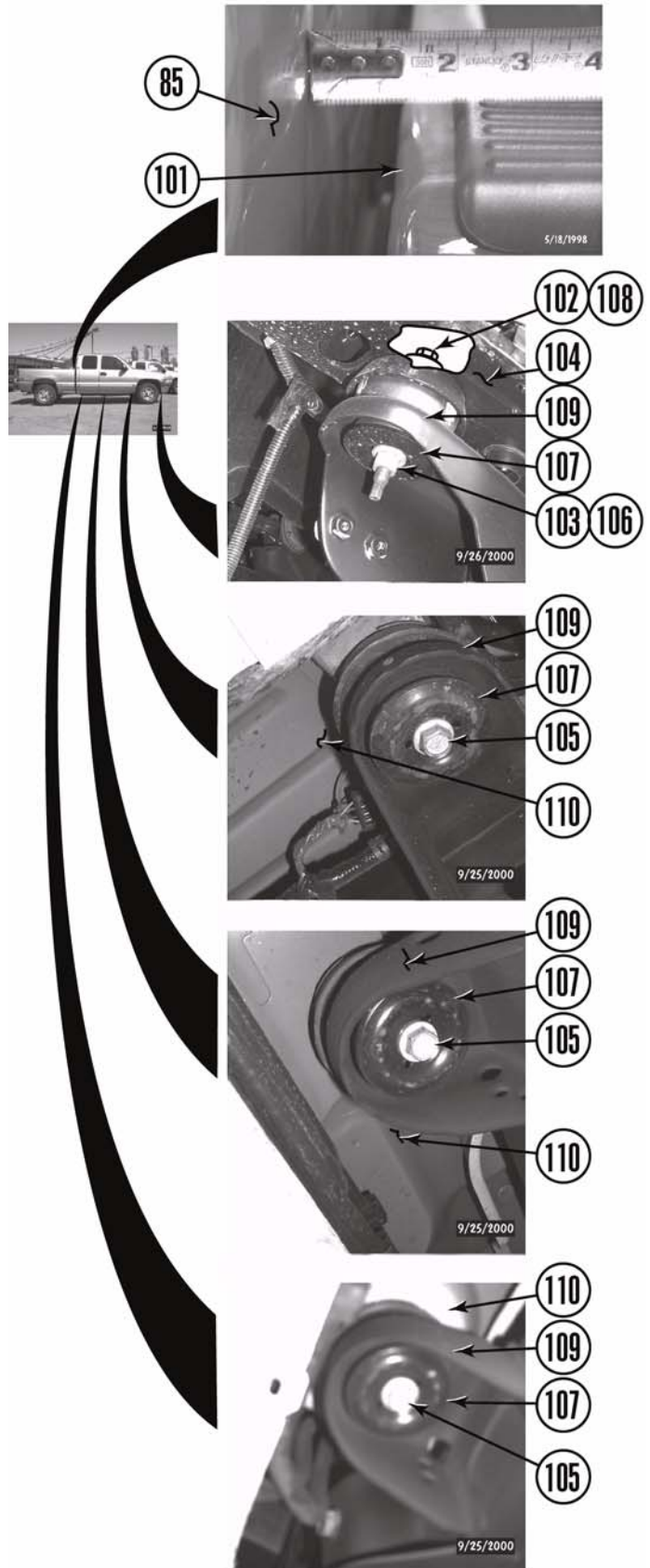

2. Lift body and install body passenger side spacer blocks.

a. Using a hydraulic jack and a wooden block, slowly lift the body (85) passenger side just high enough to position a *kit* spacer block (111) between the metal cup (112) and the passenger side core support mounting pad (104).

b. Position three *kit* spacer blocks (111) on top of the passenger side frame mounting pads (109).

c. Install a *kit* 12mm x 1.75 x 180mm bolt (113) through *kit* 7/16" USS washer (114), frame mounting pad (109), top bushing (115), metal cup (112), *kit* spacer block (111), body passenger side core support mounting pad (104), *kit* 1/2" thick washer (116), and stock nut (103). LEAVE THE BOTTOM BUSHING (107) OFF FOR NOW. Do not tighten.

d. Install three *kit* 12mm x 1.75 x 180mm bolts (113) through three *kit* 7/16" USS washers (114), frame mounting pads (109), top bushings (115), metal cups (112), *kit* spacer blocks (111), and body mounting pads (110). LEAVE THE BOTTOM BUSHING (107) OFF FOR NOW. Do not tighten.

e. Lower body (85) on the *kit* spacer blocks (111).

3. Install the body driver's side spacer blocks.

a. Repeat steps C. 1. c. and d. and C. 2. a. through e. for the body driver side.

4. Finish the body spacer block installation.

a. Remove eight bolts (113) one at a time, INSTALL THROUGH THE BOTTOM BUSHING (107) NOW, coat threads with Loctite®, and reinstall. Tighten until bottom bushing bottoms out.

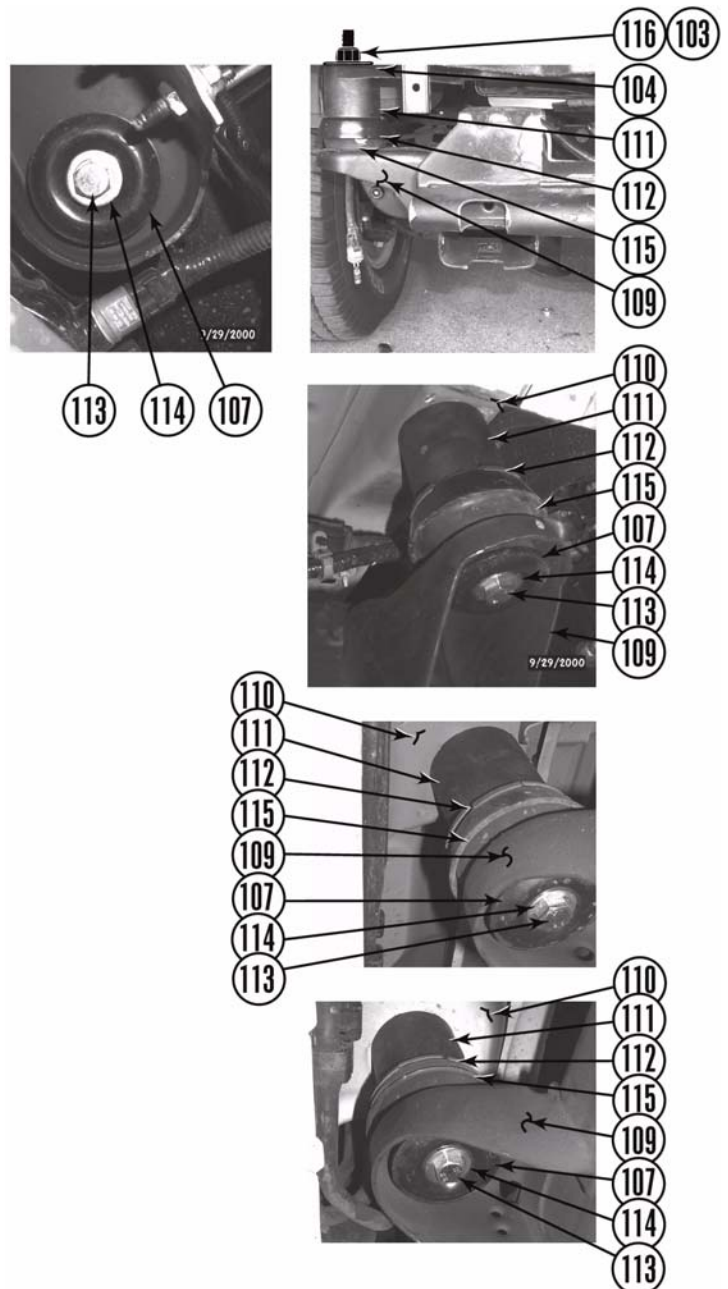

5. Lift truck bed and install passenger side spacer blocks.

⚠WARNING

Failure to replace the OEM body mounting hardware (except mounting bolts in the kit) in the stock locations could result in serious personal injury or damage to the vehicle.

- a. Loosen eight bed bolts with captive washers (117) from bed (101) and frame mounting pad (109). Do not remove.

⚠WARNING

Use extreme caution when lifting body from frame. Ensure lifting device is securely placed. Keep hands out from between frame and body, or serious personal injury could result.

⚠NOTE

Ensure stock spacers and body mounting pads stay on vehicle unless otherwise specified in these instructions. *Kit* spacer blocks are installed in addition to the stock spacers and body mounting pads.

- b. Remove four passenger side bed bolts with captive washers (117) from frame mounting pads (109).

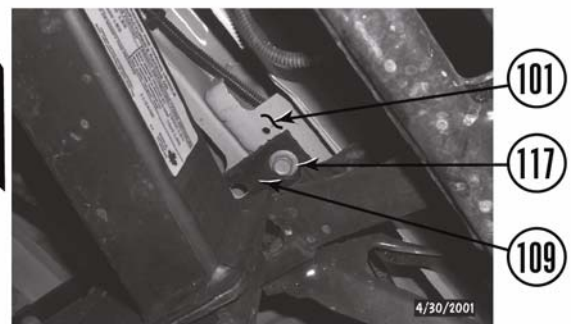
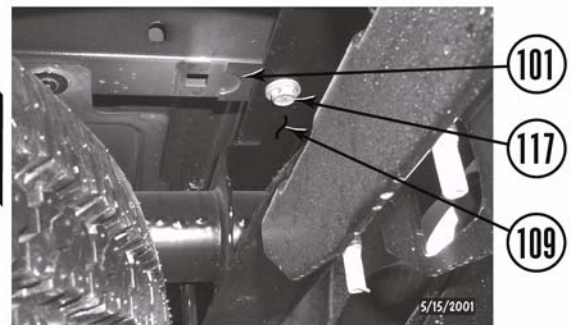
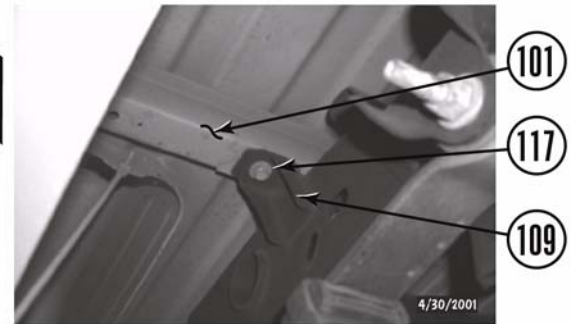
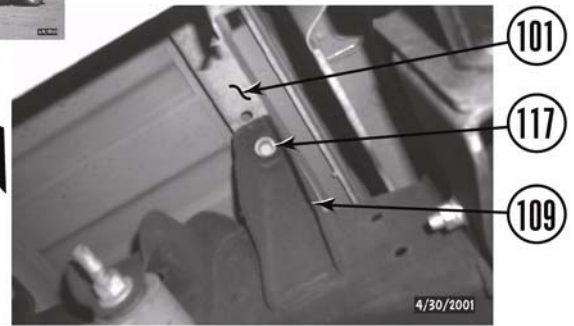

- c. Using a hydraulic jack and a wooden block, slowly lift the bed (101) passenger side just high enough to position the *kit* spacer blocks (111) between the bed and passenger side frame mounting pads (109).

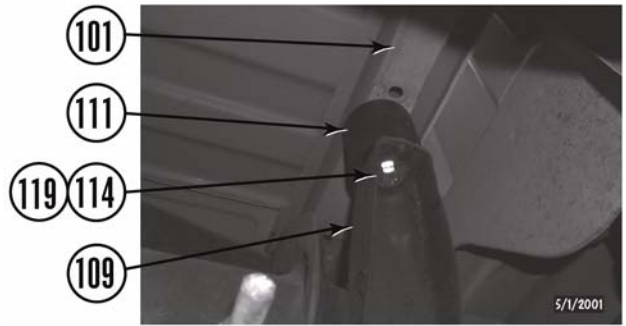

⚠NOTE
 In step C.5.d. below the *kit* 3" x 2" spacer block installed on the frame has a small center hole. It will not accommodate the 14mm bolts for the bumper in step C.19.j.

- d. Position three *kit* 3" x 3" spacer blocks (111) on top of the three forward passenger side frame mounting pads (109). Position one *kit* 3" x 2" spacer block (118) on top of rear passenger side frame mounting pad.
- e. Install four *kit* 12mm x 1.75 x 100mm bolts (119) through *kit* 7/16" USS washers (114), frame mounting pads (109), *kit* spacer blocks (111 and 118), and bed (101). Do not tighten.
- f. Lower bed (101) onto the *kit* spacer blocks (111 and 118).

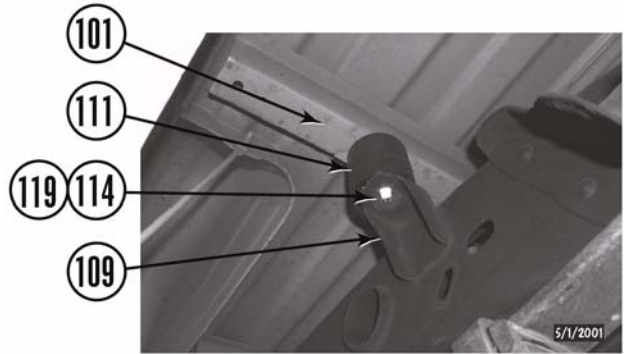

- 6. Install driver side bed spacer blocks.
 - a. Repeat steps C.5.b. through C.5.e. for the bed driver side.
- 7. Finish the bed spacer block installation.
 - a. Adjust bed (101) to cab (85) clearance using measurements taken in step C. 1. a.
 - b. Remove eight bed mounting bolts (119) one at a time, coat threads with Loctite®, and reinstall. Tighten to 55 lb-ft.

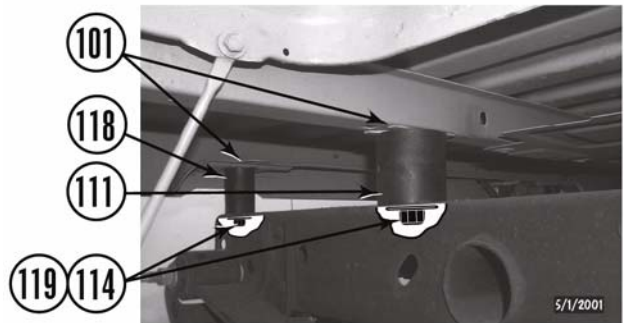

⚠WARNING

Use extreme caution when working near fuel lines and fuel tank. Clean up spilled fuel immediately. Any spark could cause an explosion or fire resulting in serious personal injury and property damage.

8. Install fuel filler.
 - a. Remove clamp (120) and filler hose (86) from gas tank (121). Leave ground wire (122) and vent hose (123) attached to fuel filler neck3.
 - b. Carefully cut filler hose (86) in half where shown. ENSURE YOU DO NOT CUT THROUGH PLASTIC TUBE (124) INSIDE FILLER HOSE.
 - c. Install *kit* extension (125) on filler hose (86) with two *kit* #36 clamps (126).
 - d. Install filler hose (86) on gas tank (121) with clamp (120).
 - e. Install fuel filler (86) on the bed (101) with three bolts (84).
 - f. Install gas cap (83).

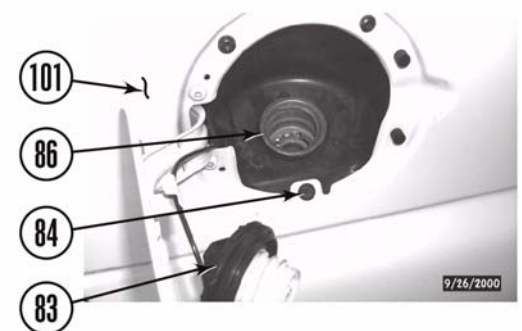
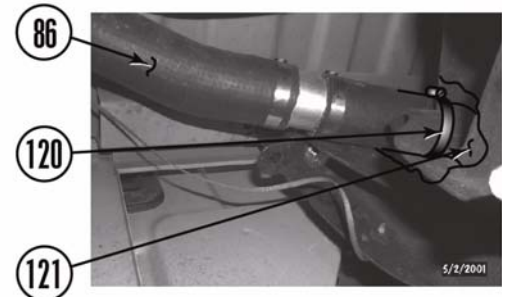
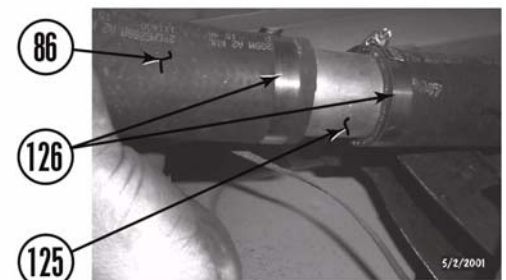
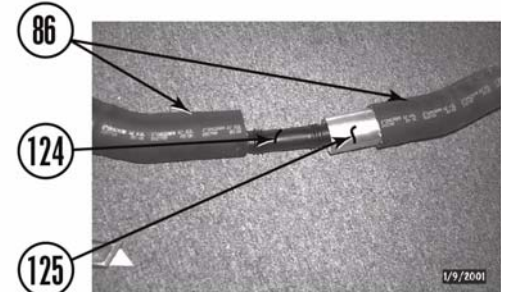
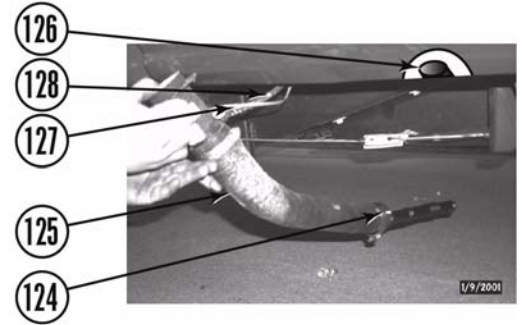

9. Along the frame rails.

a. Single cab only - install two *kit* safety cable extension brackets (126a) on frame rear mounting pads (73) with two bolts (82a).

b. Install two safety cables (82b) on kit safety cable extension brackets (126a) with two *kit* 3/8" x 1 1/2" bolts (126b), four *kit* 3/8" USS washers (126c), and two *kit* 3/8" nylock nuts (126d).

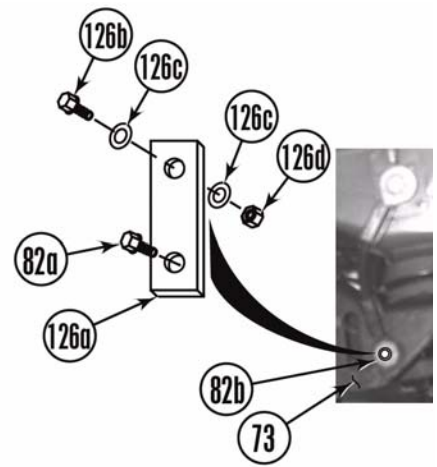

c. Install two brackets (80 and 81) and harness (82) on frame (18) passenger side with two clips (78 and 79).

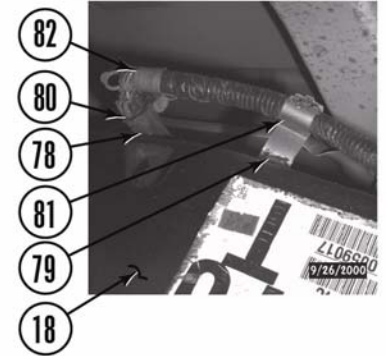

d. Install two harnesses (61 and 74) in clip (75) and clip on frame (18) drivers side.

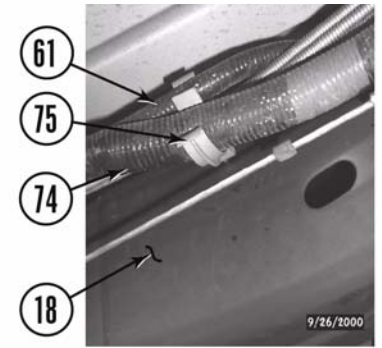

e. Install *kit* parking brake bracket (127) on frame driver side mounting pad (73) as shown with *kit* 5/16" x 1" bolt (128), two *kit* 5/16" USS washers (129), and *kit* 5/16" nylock nut (130).

f. Using *kit* bracket (127) as a template, drill a 5/16" hole as shown for the second *kit* bolt (128).

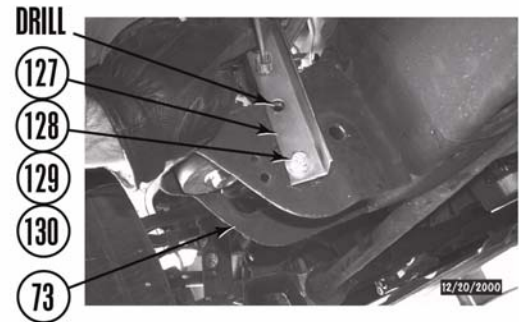

g. Install *kit* parking brake bracket (127) on frame mounting pad (73) as shown with second *kit* 5/16" x 1" bolt (128), two *kit* 5/16" USS washers (129), and *kit* 5/16" nylock nut (130).

h. Install two ground wires (71 and 72) on *kit* parking brake bracket (127) with *kit* 5/16" x 1" bolt (128), two *kit* 5/16" USS washers (129), and *kit* 5/16" nylock nut (130).

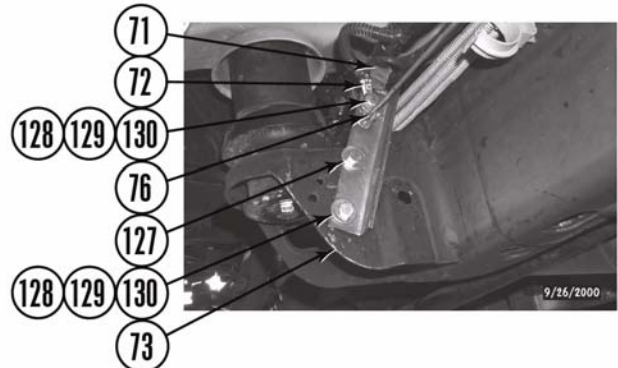

- i. Route the front parking brake cable (76) through the biggest hole in the *kit* parking brake bracket (127) and reconnect the front cable to the rear cable (77).

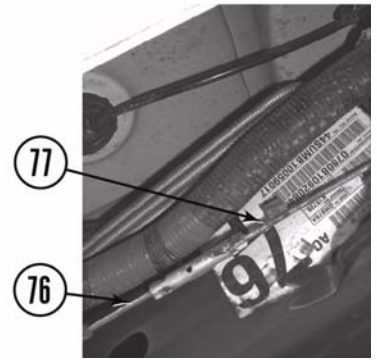

10. Automatic transmission.

NOTE
Step 10 below is for vehicles with automatic transmission only. Other models skip this step.

- a. Ensure automatic transmission cable (131) has enough slack and is not pulling on boot (132) or binding. If cable is pulling or binding, remove cable from clip (133).

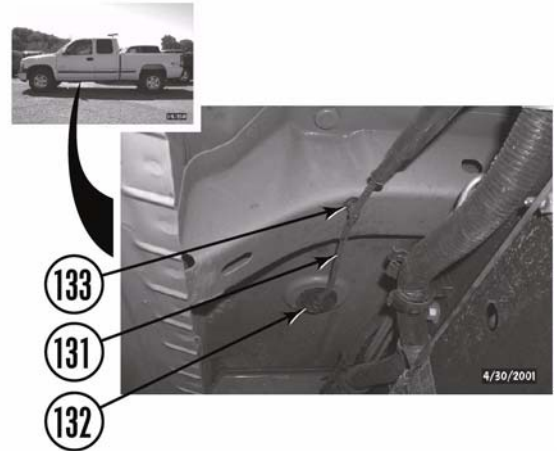

NOTE
Step 11 is for vehicles with manual transmission only. Other models skip this step.

11. Lengthen and install transmission shift lever.

- a. Remove four screws (134), four pop-ups (135), and shift boot (136) from floorboard (137). Pop-ups may need to be cut.
- b. Peel back rubber cover (138) and remove four screws (139), spring plate (140), and transmission shift lever (141) from transmission (142). Remove shift boot (136) from transmission shift lever.

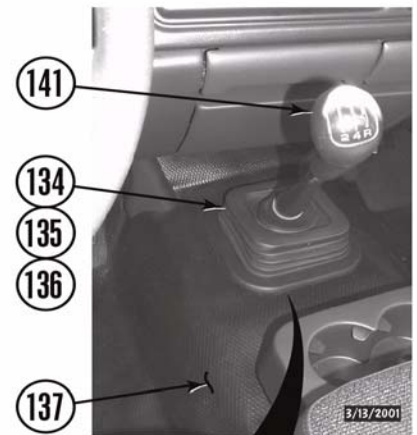

- c. Scribe a line along side of transmission shift lever (141) below the bend as shown. Cut lever into two pieces through the line and deburr as necessary.

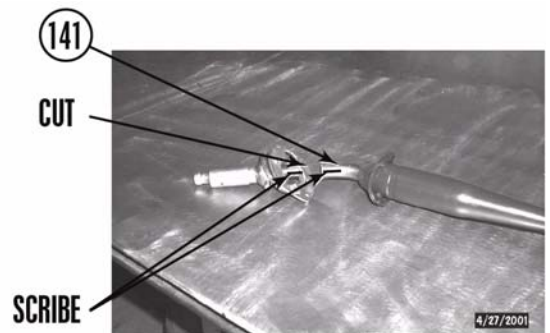

- d. Position *kit* transmission shift lever extension (143) (se4700, purchased separately) between two pieces of transmission shift lever (141). Ensure lever is all the way in and the extension and lever scribe lines align.
- e. Using the holes in *kit* extension as a guide, drill one 1/8" hole through each part of the transmission shift lever (141).
- f. Install two *kit* 1/8" x 1" roll pins (144) in holes.

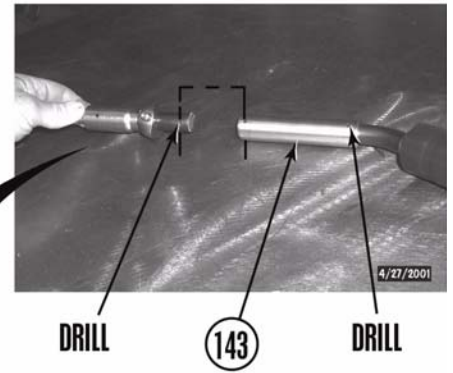
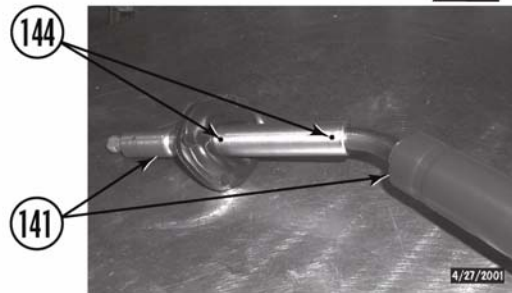

- g. Position transmission shift lever (141) in top of transmission (142) and install spring plate (140) with four screws (139). Install rubber cover (138).
- h. Check transmission shift lever operation. Ensure there is complete engagement in all gears.



- i. Install shift boot (136) on transmission shift lever (140) and floorboard (137) with four screws (134). If possible install four pop-ups (135) on shift boot and floorboard. Check transmission shift lever operation again.

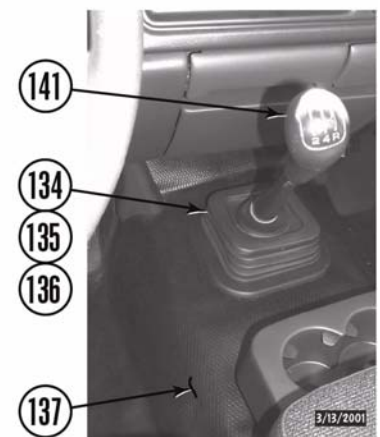

NOTE

Step 12 is for vehicles with manual transfer case only. Other models skip this step.

12. Lengthen and install transfer case shift lever.
 - a. Remove three lines (145) from bracket (146).
 - b. Remove two nuts (147) and bracket (146) from transfer case (158).
 - c. Remove two clips (159) and transfer case linkage rod (160) from transfer case (158) and pivot (161).
 - d. Scribe a line along the side of transfer case linkage rod (160) as shown. Cut the rod into two pieces through the line and deburr as necessary.

WARNING

A certified welder should perform all welding.

- e. Position *kit* transfer case linkage rod extension (162) between the two pieces of transfer case linkage rod (160). Ensure extension and lever scribed lines align and weld extension in place.
- f. Install transfer case linkage rod (160) on transfer case (158) and pivot (161) with two clips (159).
- g. Check transfer case shift lever operation. Ensure there is complete engagement in all ranges. If necessary, adjust the linkage.

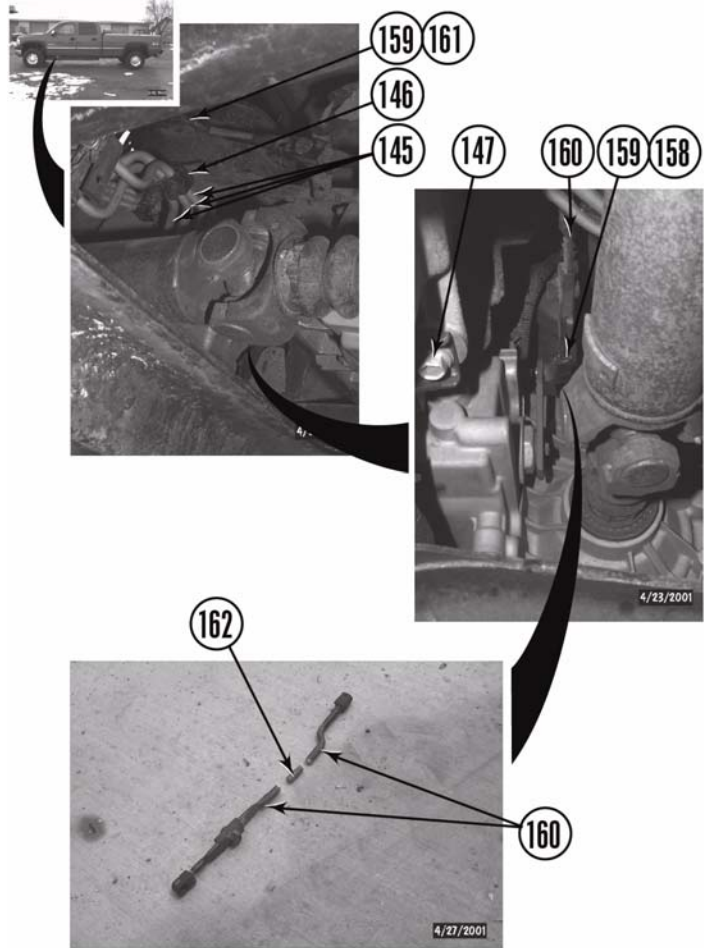

13. Under the hood.

- a. Install two brake lines (66) in two sets of clips (67).

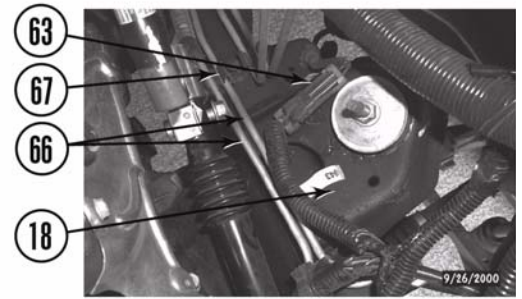

- b. If possible, install three clips (62, 63, and 64) in frame (18) driver side and wheel well (65).

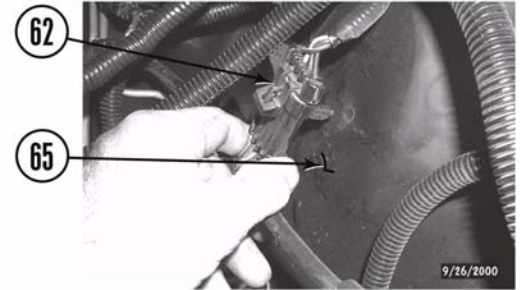

- c. If possible, install harness (61) in clip (60) and clip in frame (18) driver side.

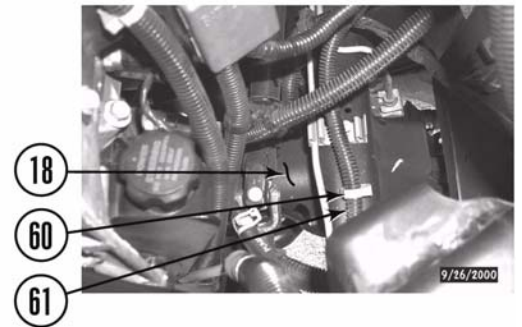

- d. If possible, install clip (58) in bracket (59).

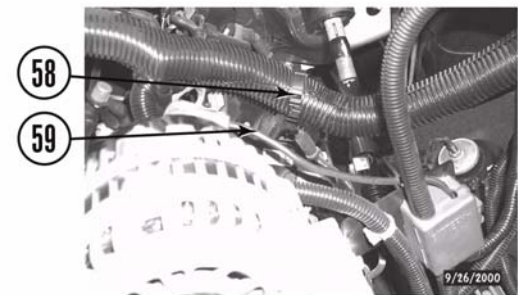

- e. Install *kit* bracket (163) on stud (57) with nut (55).

- f. Install ground strap (56) on *kit* bracket (163) with *kit* 1/4" x 1" bolt (164), two *kit* 1/4" SAE washers (165), and *kit* 1/4" nylock nut (166).

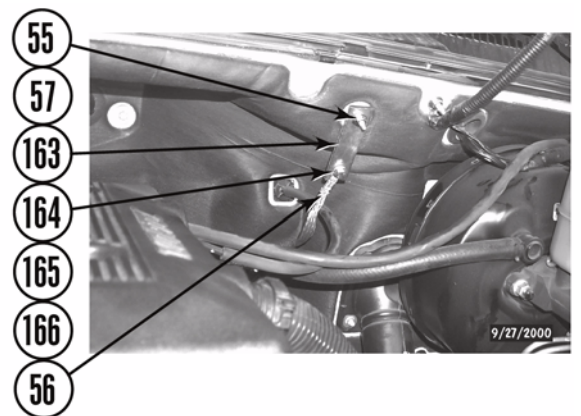

14. Install *kit* steering extension.

- a. Coat threads of retaining bolts (51 and 167) with Loctite®.
- b. Install *kit* steering extension (168) on upper steering shaft (53) with *kit* 3/8" x 1 3/4" retaining bolt (167), two *kit* 3/8" SAE washers (169), and *kit* 3/8" nylock nut (170). Do not tighten.
- c. Install lower steering shaft (54) on *kit* steering extension (168) with the stock retaining bolt (51) and clip (52). Tighten bolts (51 and 167) to 33 lb-ft.

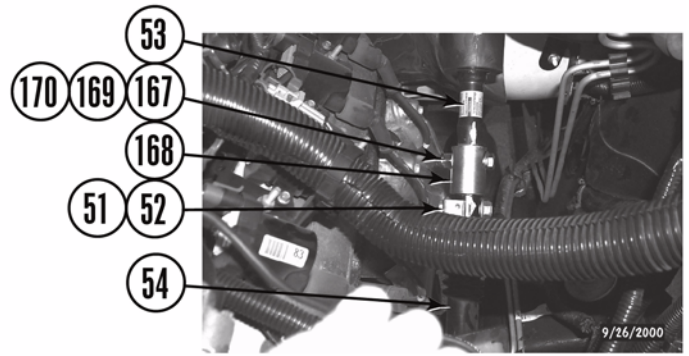

15. Radiator.

- a. Remove two center harness clips (171) from core support (9). Remove two clips from harness (172).
- b. Position two *kit* clamps (173) on harness (172).
- c. Install two *kit* clamps (173) and two *kit* lower fan shroud mounting brackets (174) on the core support (9) with two *kit* 1/4" x 1" bolts (164), two *kit* 1/4" SAE washers (165), and two *kit* 1/4" nylock nuts (166).

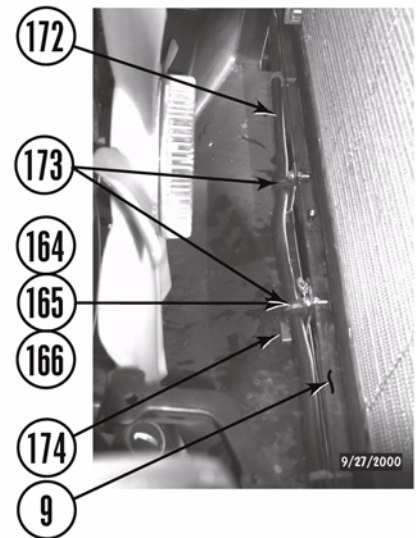
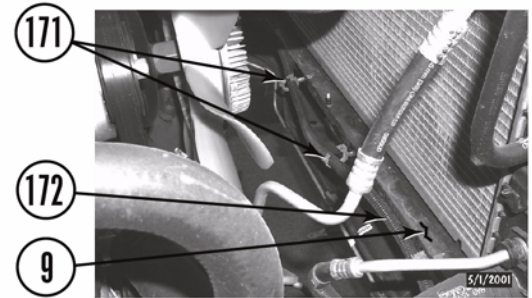

- d. Position lower fan shroud (49) in vehicle and rest on lower fan shroud mounting brackets (174).
- e. Install two *kit* upper fan shroud mounting brackets (175) on core support (9) with two bolts with captive washers (46). Do not tighten.
- f. Install top fan shroud (48) on *kit* mounting brackets (175) with two *kit* 1/4" SAE washers (165) and *kit* 1/4" nylock nuts (166). Do not tighten.

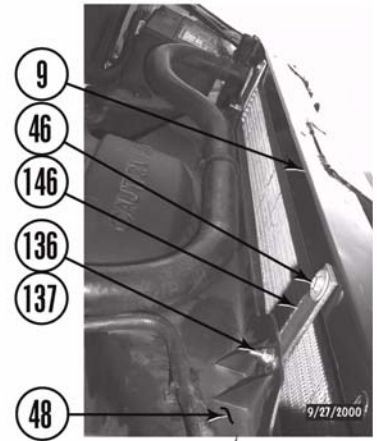

- g. Install top fan shroud (48) on bottom fan shroud (49) with four pop-ups (47). Check fan to fan shroud clearance. Ensure gap is the same all around shroud.



- h. Using two *kit* lower fan shroud support brackets (174) as a template, mark and drill two 5/16" holes in the bottom fan shroud (49) from front of vehicle up through shroud as shown.
- i. Install bottom fan shroud (49) on two *kit* lower fan shroud support brackets (174) with two *kit* 1/4" x 1" bolts (164), four *kit* 1/4" SAE washers (165), and two *kit* 1/4" nylock nuts (166). Ensure bolt threads point out of shroud.

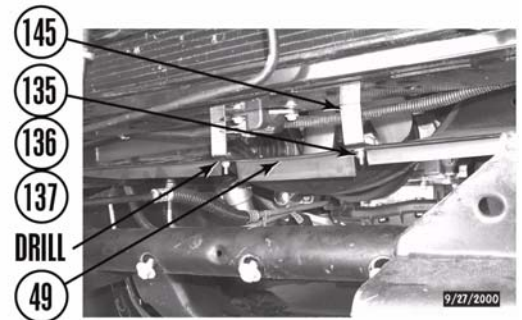

- j. Check fan to fan shroud clearance. Ensure gap is the same all around shroud and tighten bolts (164) and nuts (166).

- k. Position air duct (43) on air filter housing (44) and throttle body (45) and tighten two clamps (41 and 42).

- l. Install hose (38) in two clamps (39 and 40).

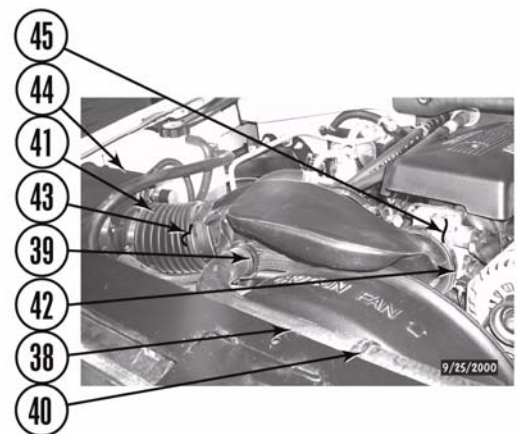

16. Transmission cooler (If so equipped).

- a. Install two *kit* S-brackets (176) on core support (9) with bolts (32). Do not tighten.
- b. Install transmission cooler (34) on two *kit* S-brackets (176) with two *kit* 1/4" SAE washers (165) and *kit* 1/4" nylock nuts (166). Do not tighten.
- c. Install two *kit* tubes (177) with two 1/4" x 3" bolts (178), four 1/4" SAE washers (165), and two 1/4" nylock nuts (166).
- d. Tighten nuts (166) and bolts (32 and 178).

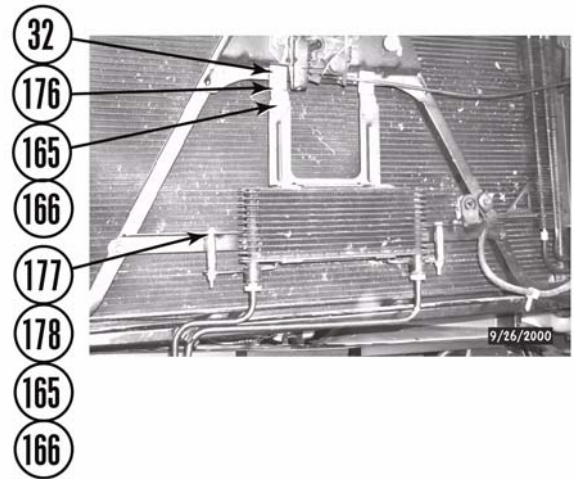

- e. If removed, install air flap (30) on core support (9) with three panel clips (31).
- f. If removed, install clip (28) and harness (29) in air flap (30).
- g. You may need to trim the air flap (30) as shown if a test fit indicates it interferes with the *kit* bumper brackets to be installed in step 17. below.

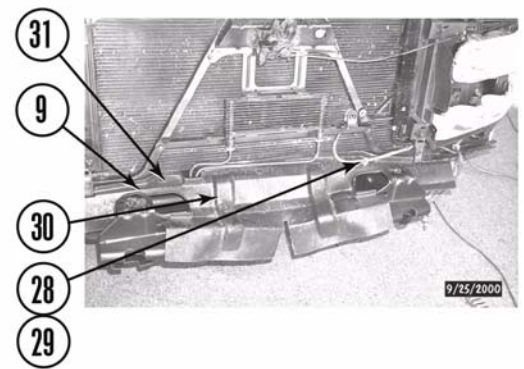

- h. Install plastic cover (27) on frame (18) and core support (9) with five bolts with captive washers (26).

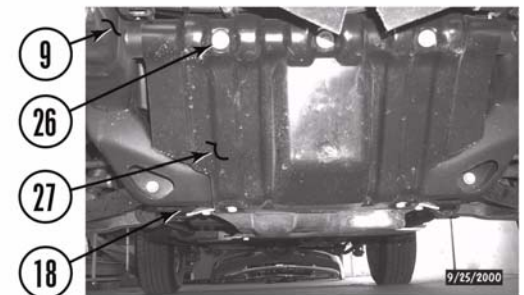

17. Install the front bumper.

- a. Carefully bend hard line (35) (if present) as shown and secure with *kit* zip tie (179).
- b. Trim the two front frame crush zones (180) as shown.

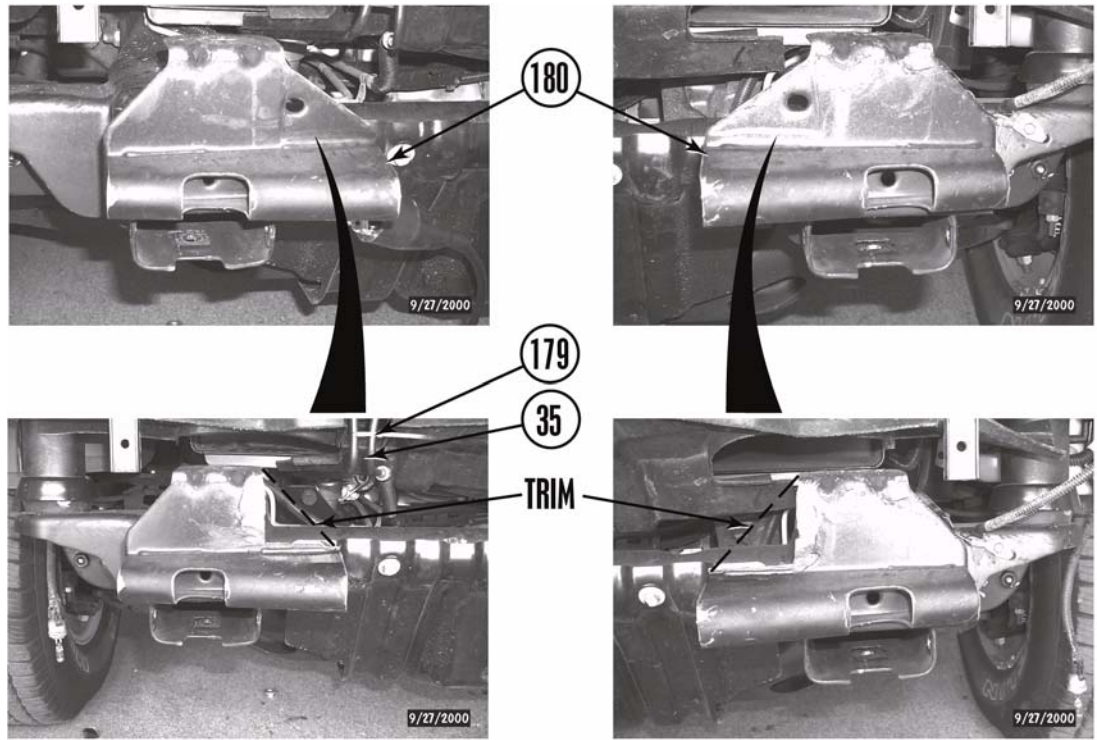

- c. Trim the front bumper valance (181) in two places as shown.

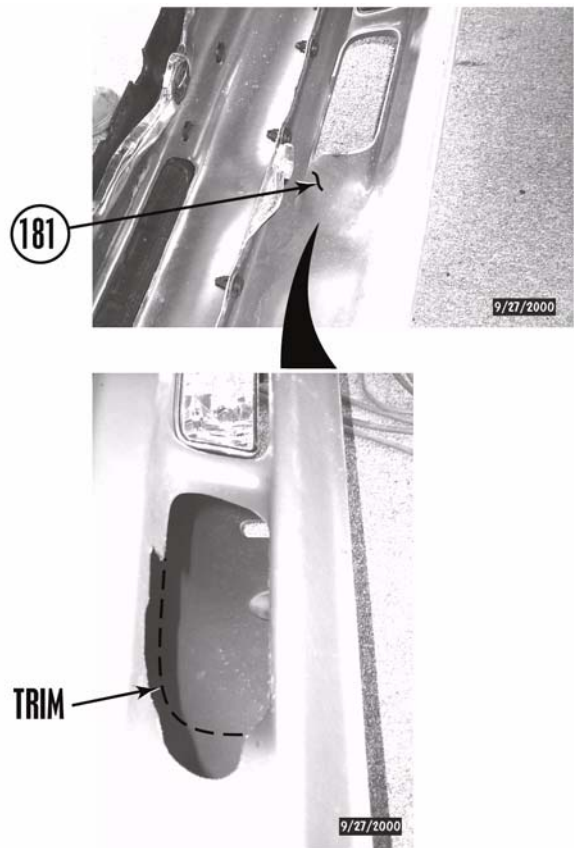

d. Coat threads of bolts (16,19, and 182) and nuts (185) with Loctite®.

e. Install two *kit* bumper brackets (183) on frame (18) with two stock bolts (19), two *kit* 7/16" x 1 1/2" bolts (182), four *kit* 7/16" USS washers (184), and two *kit* 7/16" nylock nuts (185). Do not tighten.

f. Install *kit* small bumper brackets (186) on *kit* bumper brackets (183) with four *kit* 7/16" x 1 1/2" bolts (182), eight *kit* 7/16" USS washers (184), and four *kit* 7/16" nylock nuts (185). Do not tighten.

g. Install front bumper (15) on two *kit* bumper brackets (183) and two *kit* small bumper brackets (186) with four *kit* 7/16" x 1 1/2" bolts (182), eight *kit* 7/16" USS washers (184), and four *kit* 7/16" nylock nuts (185). Do not tighten.

h. Install two *kit* side bumper brackets (187) on frame (18) with four bolts (16). Do not tighten.

i. Position four *kit* 7/16" x 1 1/2" bolts (182) and *kit* 7/16" USS washers (184) in top holes on *kit* side bumper brackets (187) as shown. Position side brace bracket (17) over bolts (182) and install four *kit* 7/16" USS washers (184) and *kit* 7/16" nylock nuts (185). Do not tighten.

j. Install two side brace brackets (17) on front bumper (15) with two bolts (16).

k. Adjust bumper to body clearance using measurements from step B. 2. a. and tighten bolts (16, 19, and 182), and nuts (185) to 55 lb-ft.

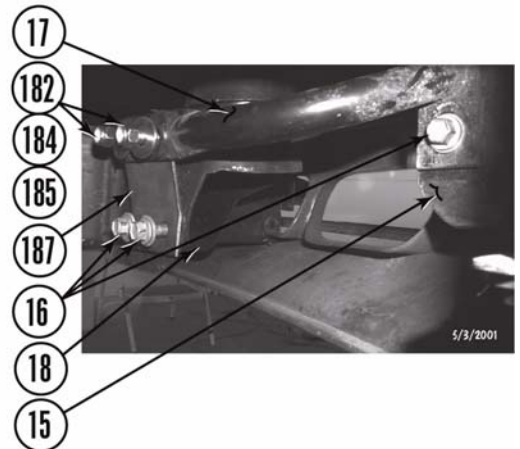
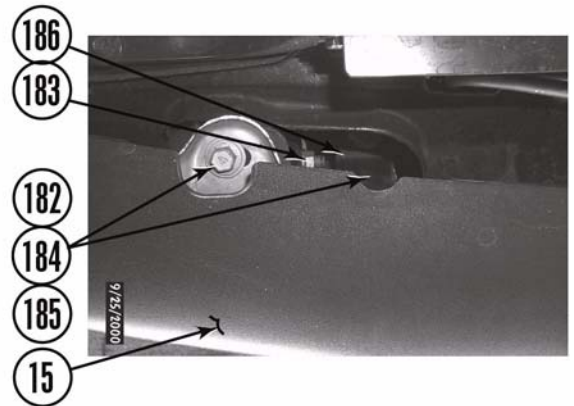
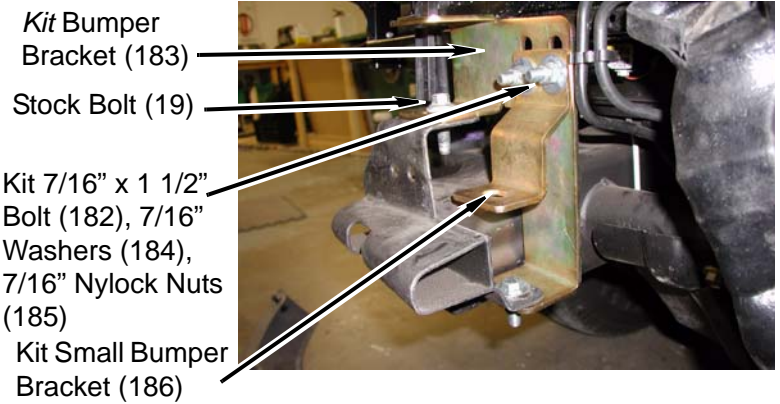

18. Install the grille.

- a. Position grille (13) on core support (9) and install two clips (12) in front fenders (14).

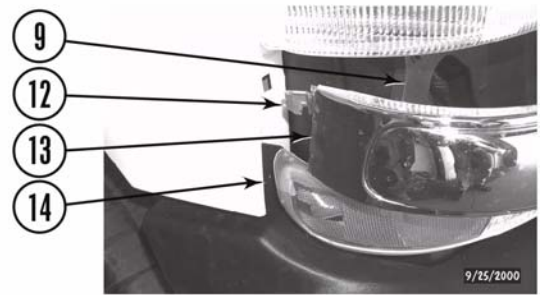

- b. Tighten four phillips head/dzeus fasteners (11) and install bolt with captive washer (10).



- c. Install cover (8) on core support (9) with seven panel clips (7).



⚠WARNING
The following procedure is intended only to enhance the appearance of the vehicle. The rear bumper will no longer be rated for towing of any kind. Towing with the rear bumper after it has been lifted can result in death, serious personal injury, or damage to the vehicle. Towing after the bumper has been lifted should be accomplished using a rated Class III receiver type hitch.

19. Install the rear bumper.

- a. Move spare tire winch access tube (188) to center of rear frame crossmember (189). Position *kit* conduit clamp (190) over winch access tube. Mark and drill frame cross member using a #21 drill bit.

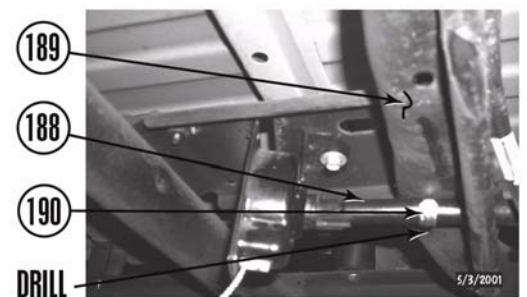

- b. Install conduit clamp (190) over winch access tube (188) and on frame crossmember (189) with *kit* 3/4" sheet metal screw (191).
- c. Coat threads of bolts (97, 98, 99, and 193) and nuts (100, 185, 197, and 199) with Loctite®.
- d. Install two *kit* rear bumper brackets (192) on rear bumper (87) with four bolts with captive washers (99) and four nuts with captive washers (100). Do not tighten.

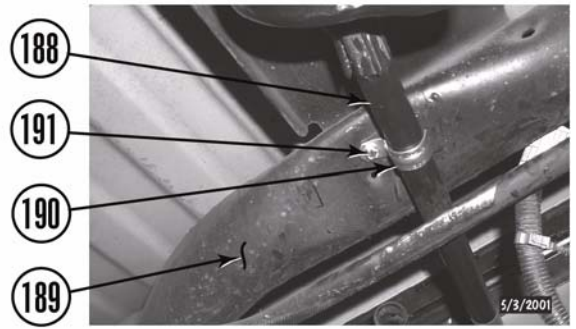

- e. With the two outside bumper brackets (95) rotated out, position two *kit* rear bumper brackets (192) in frame rails (18).
- f. Install two *kit* 3/8" x 1 1/2" bolts (193), four *kit* 3/8" SAE washers (169), and two *kit* 3/8" nylock nuts (170) in frame (18) and *kit* bumper bracket (192). Do not tighten.
- g. Install two *kit* 7/16" x 1 1/2" bolts (194) and two *kit* 7/16" USS washers (195) in two *kit* 3-stud brackets (196).

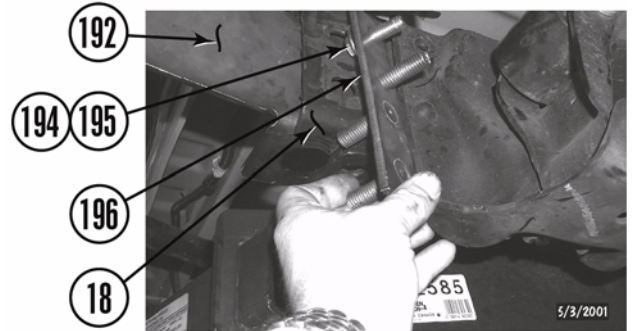

- h. Position two *kit* 3-stud brackets (196) through frame rails (18) and *kit* rear bumper brackets (192). Rotate outside bumper brackets (95) in over bolts (194) and install two *kit* 7/16" USS washers (195), two *kit* 7/16" nylock nuts (197), six *kit* 1/2" USS washers (184), and six *kit* 1/2" nylock nuts (185) on *kit* 3-stud bracket. Do not tighten.
- i. If equipped with a trailer hitch (96), install hitch on frame (18) with two bolts (97), two *kit* square washers (198), and two *kit* 14mm nylock nuts (199).

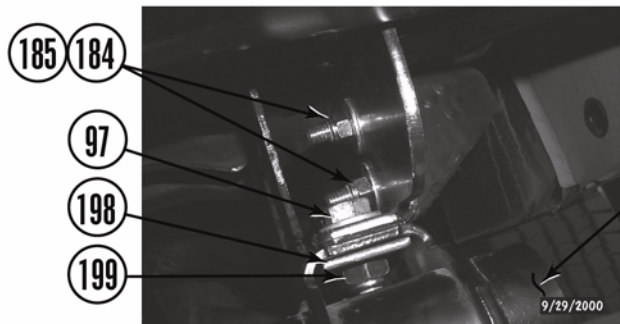

- j. Position two *kit* 3" x 2" spacer blocks (200) between rear bumper (87) and hitch (96) and install two *kit* 14mm washers (201) and 14mm x 110mm bolts (202).

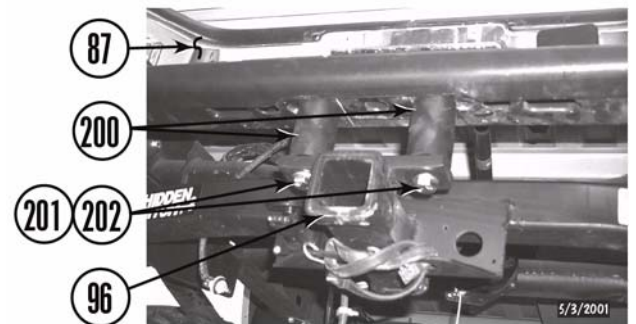

- k. Adjust bumper to body clearance using measurements from step B. 7. a. and tighten bolts (97, 98, 99, 193, and 202) and nuts (100, 185, 197, and 199) to 55 lb-ft.
- l. Connect two license plate lights (89) in rear bumper (87).
- m. Install license plate onto bumper with hardware.

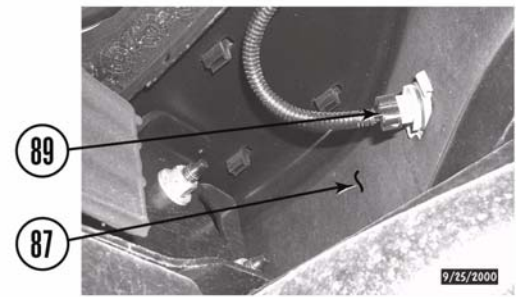

NOTE
Installing a hinged license plate holder will allow easier access to the spare tire winch tube.

20. Install crush blocks.

NOTE
Short wheel base trucks have two plastic disks and use two *kit* crush blocks.

- a. Remove four plastic disks (203) from frame (18).
- b. Install four *kit* crush blocks (204) on frame (18) with four *kit* 5/16" USS washers (205) and four *kit* 5/16" x 3/4" self tapping bolts (206).

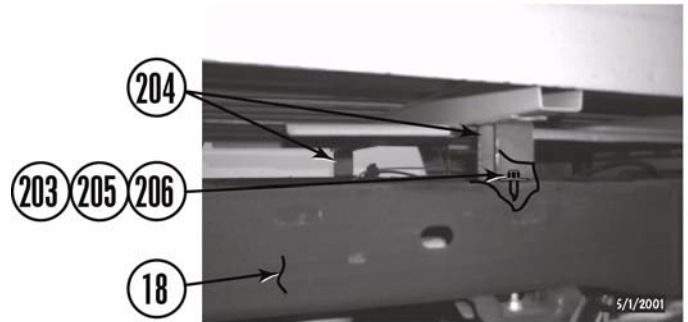

D. After installation is complete.

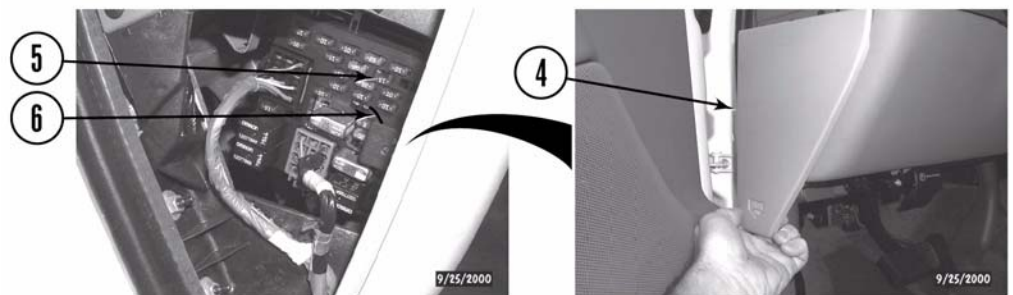

- 1. Install airbag fuse (5) in fuse panel (6). Install cover (4).
- 2. Connect both battery cables to the battery (3). Be sure to reconnect the positive cable (2) first, then the negative cable (1).
- 3. Stick *kit* warning sticker on the dash in plain sight of all vehicle occupants.
- 4. Double check the vehicle.



CAUTION
Re torque all fasteners after 500 miles and after off road use. All body lift components should be visually inspected and fasteners re torqued during routine vehicle servicing.

- a. Check all mounting hardware to ensure it is properly tightened.

- b. Check all wires, hoses, cables, etc. to ensure they have been properly connected and there is ample slack. With the number of hoses on this vehicle, it is vital that this be checked thoroughly.
- c. Check vehicle electrical system.
- d. Start vehicle and check the steering in both directions to ensure that there is no bind. Check clutch operation. Check the operation of the brake system and the parking brake. Check both shift levers' operation. Ensure that there is proper engagement in all gears and 4 wheel drive ranges.

⚠CAUTION

Never open a closed cooling system after the vehicle has been started. Only fill the cooling system if the cap has been removed while the vehicle was still cold.

- e. Check coolant level. Fill coolant to the proper level (refer to the Owner's Manual).
- f. Test drive vehicle in all gears and 4 wheel drive ranges. Pay close attention to all vehicle systems. Check all hardware again in 500 miles and as part of your regular maintenance schedule.

⚠CAUTION

Performance Accessories does not recommend any particular wheel and tire combinations for use with its body lifts and cannot assume responsibility for the customer's choice of wheels and tires. Reference your owner's manual for recommended tire sizes and warnings related to the use of oversized tires. Larger wheel and tire combinations increase stress and wear on steering and suspension components, which leads to increased maintenance and higher risk for component failure. Larger wheel and tire combinations also alter speedometer calibration, braking effectiveness, center of gravity, and handling characteristics. Consult with an experienced local off road shop to find what wheel and tire combinations work best with your vehicle.

⚠NOTE

All warranty information, instruction sheets, and other documents regarding the installation of this product must be retained by the vehicle owner. Information contained in the instructions and on the warranty card will be required for any warranty claims. The vehicle owner needs to understand the modifications made to his vehicle and how they affect vehicle handling and performance. Failure to provide the customer with this information can result in damage to the vehicle and severe personal injury.

E. Kit Parts List.

Quantity	Description
14	3" x 3" blocks
2	3" x 2" blocks
2	3" x 2" 5/8" through hole blocks
2	Front outer bumper brackets
2	Front inner bumper brackets
2	Front L-shaped inner bumper brackets
2	Rear bumper brackets
2	3 stud bracket
1	Fuel filler extension
4	Crush blocks (2 - short bed)
2	Cab safety strap extension brackets
1	Warning to driver sticker
1	Logo sticker
1	6ml bottle Loctite
1	Bolt pack BP10053
	Bolts
8	12mm x 1.75 x 180mm bolts
8	12mm x 1.75 x 100mm bolts
2	14mm x 2.00 x 110mm bolts
3	5/16" x 1" bolts
1	3/8" x 1 3/4" bolt
	Washers
2	14mm USS washers
6	1/2" USS washers
6	5/16" USS washers
2	3/8" SAE washers
16	7/16" USS washers
2	1/2" thick washers
	Nuts
6	1/2" nylock nuts
3	5/16" nylock nuts
1	3/8" nylock nut
	Miscellaneous
1	Parking brake bracket
1	Steering extension
1	Hardware pack HP10053
	Bolts
16	7/16" x 1 1/2" bolts
2	1/4" x 3" bolts
5	1/4" x 1" bolts
4	3/8" x 1 1/2" bolts
	Washers
32	7/16" USS washers
16	1/4" SAE washers
8	3/8" USS washers
2	1 1/2" x 2 1/2" rect. washers
	Nuts
16	7/16" nylock nuts
11	1/4" nylock nuts
4	3/8" nylock nuts
2	14mm nylock nuts
	Miscellaneous
1	3" ground strap
2	3" upper fan shroud bracket
2	#36 hose clamps
1	1/2" linkage rod extension
1	Zip tie

Quantity	Description
2	3" L-shaped rad brackets
2	2" Tubes
2	2" S-shaped brackets
2	Harness clamps (rubber clad)
1	Conduit clamp
1	Sheet metal screw
4	5/16" self tapper (2 - short bed)
4	5/16" USS washers (2-short bed)



Inner front bumper brackets (assembled)



Outer front bumper bracket



Fan shroud bracket



Parking brake bracket



L-shaped bracket